

WF5837-02BA

APPLICATIONS

- Fitness Trackers
- Drones
- Bike Computers
- Mobile Altimeter/Barometer Systems
- E-cigarettes
- Wearables



Gel-filled, ultra-compact, water resistant digital pressure and temperature sensor

Take your devices to the next level with our WF5837-02BA pressure and temperature sensor module. This ultra-compact (3.3 x 3.3 x 2.75 mm), gel-filled sensor is optimized for consumer devices such as fitness trackers, drones and wearables, providing a robust sensor package to withstand the harsh environments often encountered in these applications.

Expanding on TE Connectivity's (TE) WF5837 series of ultra-compact, digital altimeters, our 2 bar models offers options for shielding and high chemical endurance.

This MEMS based sensor includes a high-linearity pressure sensor with low power (0.6 μ A), 24-bit digital output (I²C) and an altitude resolution at sea level of 13 cm. This enables high resolution measurements such as counting flights of stairs. The board level design delivers sensing accuracy for both pressure (± 0.5 mbar) and temperature ($\pm 2^\circ$ C) measurements. Lid shield option reduces signal noise and interference that may be experienced with sensors installed in plastic housings or high electrical noise environments with integrated shielding.

(Non-shielded models should only be recommended for use in applications with metal housings.)

Our WF5837-02BA provides exceptional performance, reliability and accurate performance from a brand you can trust.

FEATURES

- Ceramic and metal package: 3.3 x 3.3 x 2.75mm
- High resolution module: 13 cm
- Supply voltage: 1.5 to 3.6 V
- Low power: 0.6 μ A (standby $\leq 0.1 \mu$ A at 25 $^\circ$ C)
- Integrated digital pressure sensor (24 bit $\Delta\Sigma$ ADC)
- Operating range: 300 to 1,200 mbar, -20 to +85 $^\circ$ C
- I²C interface
- No external components (internal oscillator)
- Water resistant sealing with 1.8 x 0.8mm O-ring
- Shielded metal lid option



PREFORMANCE SPECIFCIATIONS

ABSOLUTE MAXIMUM RATINGS

| Parameter | Symbol | Conditions | Min. | Typ. | Max | Unit |
|--|------------------|--------------------------|------|------|------|------|
| Supply voltage | V _{DD} | | -0.3 | | +4 | V |
| Storage temperature | T _S | | -40 | | +85 | °C |
| Overpressure | P _{max} | ISO 22810 ⁽¹⁾ | | | 10 | bar |
| Maximum Soldering Temperature ⁽²⁾ | T _{max} | 40 sec. max | | | 250 | °C |
| ESD rating (lid to GND version) | | Human Body Model | -2 | | +2 | kV |
| Latch up | | JEDEC JESD78 standard | -100 | | +100 | mA |

⁽¹⁾ Pressure ramp up/down min 60s

⁽²⁾ Refer to application note 808

ELECTRICAL CHARACTERISTICS

| Parameter | Symbol | Conditions | Min. | Typ. | Max | Unit |
|---|-----------------|--------------------------------------|------|-------|-----|------|
| Operating Supply voltage | V _{DD} | | 1.5 | 3.0 | 3.6 | V |
| Operating Temperature | T | | -20 | +25 | +85 | °C |
| Supply current (1 sample per sec.) | I _{DD} | OSR | | | | μA |
| | | 8192 | | 20.09 | | |
| | | 4096 | | 10.05 | | |
| | | 2048 | | 5.02 | | |
| | | 1024 | | 2.51 | | |
| | | 512 | | 1.26 | | |
| | | 256 | | 0.63 | | |
| Peak supply current | | during conversion | | 1.25 | | mA |
| Standby supply current | | at 25°C (V _{DD} = 3.0 V) | | 0.01 | 0.1 | μA |
| Power supply hold off for internal reset ⁽³⁾ | | V _{DD} < 0.1V | 200 | | | ms |
| VDD Capacitor | | from VDD to GND | 100 | 470 | | nF |
| Resistor value between the lid and the GND | | Version 02BA2x only | | 1000 | | Ω |

⁽³⁾ Supply voltage power up must be continuous from GND to VDD without any step

ANALOG DIGITAL CONVERTER (ADC)

| Parameter | Symbol | Conditions | Min. | Typ. | Max | Unit |
|------------------------------------|----------------|------------|------|-------|------|------|
| Output Word | | | | 24 | | bit |
| ADC Conversion time ⁽⁴⁾ | t _c | OSR | | | | ms |
| | | 8192 | | 16.44 | 17.2 | |
| | | 4096 | | 8.22 | 8.61 | |
| | | 2048 | | 4.13 | 4.32 | |
| | | 1024 | | 2.08 | 2.17 | |
| | | 512 | | 1.06 | 1.10 | |
| | | 256 | | 0.54 | 0.56 | |

⁽⁴⁾ Maximum values must be used to determine waiting times in I²C communication



+

PERFORMANCE SPECIFICATIONS (Continued)

PRESSURE OUTPUT CHARACTERISTICS ($V_{DD} = 3\text{ V}$, $T = 25^\circ\text{C}$ UNLESS OTHERWISE NOTED)

| Parameter | Conditions | Min. | Typ. | Max | Unit |
|--|---|------|---------|------|---------|
| Operating Pressure Range | P_{range} | 300 | | 1200 | mbar |
| Extended Pressure Range | P_{ext} Linear Range of ADC | 10 | | 2000 | mbar |
| Relative Accuracy ⁽¹⁾⁽⁴⁾ | 600...1000 mbar, at 20°C | -0.5 | | +0.5 | mbar |
| | 300...1100 mbar, $0...60^\circ\text{C}$ | -2 | | +2 | |
| | 300...1100 mbar, $-20...85^\circ\text{C}$ | -4 | | +4 | |
| Resolution RMS | OSR | 8192 | 0.016 | | mbar |
| | | 4096 | 0.021 | | |
| | | 2048 | 0.028 | | |
| | | 1024 | 0.039 | | |
| | | 512 | 0.062 | | |
| | | 256 | 0.11 | | |
| Maximum error with supply voltage ⁽²⁾ | $V_{DD} = 1.5\text{ V}...3.6\text{ V}$ | | ± 2 | | mbar |
| Long-term stability | | | ± 2 | | mbar/yr |
| Reflow soldering impact | IPC/JEDEC J-STD-020C (Refer to application note AN808) | | ± 4 | | mbar |
| Recovering time after reflow ⁽³⁾ | | | 7 | | days |

⁽¹⁾ With autozero at one pressure point⁽²⁾ With autozero at 3V point⁽³⁾ Time to recover at least 66% of reflow impact⁽⁴⁾ Wet/dry cycle: sensor must be dried typically once a day

TEMPERATURE OUTPUT CHARACTERISTICS ($V_{DD} = 3\text{ V}$, $T = 25^\circ\text{C}$ UNLESS OTHERWISE NOTED)

| Parameter | Conditions | Min. | Typ. | Max | Unit |
|-----------------------------------|--|------|-----------|-----|------------------|
| Relative Accuracy | $-20...85^\circ\text{C}$, 300...1100 mbar | -2 | | +2 | $^\circ\text{C}$ |
| Maximum error with supply voltage | $V_{DD} = 1.5\text{ V}...3.6\text{ V}$ | | ± 0.3 | | $^\circ\text{C}$ |
| Resolution RMS | OSR | 8192 | 0.002 | | $^\circ\text{C}$ |
| | | 4096 | 0.003 | | |
| | | 2048 | 0.004 | | |
| | | 1024 | 0.006 | | |
| | | 512 | 0.009 | | |
| | | 256 | 0.012 | | |

DIGITAL INPUTS (SDA, SCL)

| Parameter | Symbol | Conditions | Min. | Typ. | Max | Unit |
|-----------------------|-------------------|------------------------|---------------|------|----------------|---------------|
| Serial data clock | SCL | | | | 400 | KHz |
| Input high voltage | V_{IH} | | $80\% V_{DD}$ | | $100\% V_{DD}$ | V |
| Input low voltage | V_{IL} | | $0\% V_{DD}$ | | $20\% V_{DD}$ | V |
| Input leakage current | I_{leak} | $T = 25^\circ\text{C}$ | | | 0.1 | μA |

DIGITAL OUTPUTS (SDA)

| Parameter | Symbol | Conditions | Min. | Typ. | Max | Unit |
|---------------------|----------|-----------------------------------|---------------|------|----------------|------|
| Output high voltage | V_{OH} | $I_{\text{source}} = 1\text{ mA}$ | $80\% V_{DD}$ | | $100\% V_{DD}$ | V |



| | | | | | | |
|--------------------|----------|--------------------------|--------------|--|---------------|---|
| Output low voltage | V_{OL} | $I_{sink} = 1\text{ mA}$ | $0\% V_{DD}$ | | $20\% V_{DD}$ | V |
|--------------------|----------|--------------------------|--------------|--|---------------|---|



TYPICAL PERFORMANCE CHARACTERISTICS

RELATIVE PRESSURE ERROR AND TEMPERATURE ERROR VS PRESSURE AND TEMPERATURE (TYPICAL VALUES)

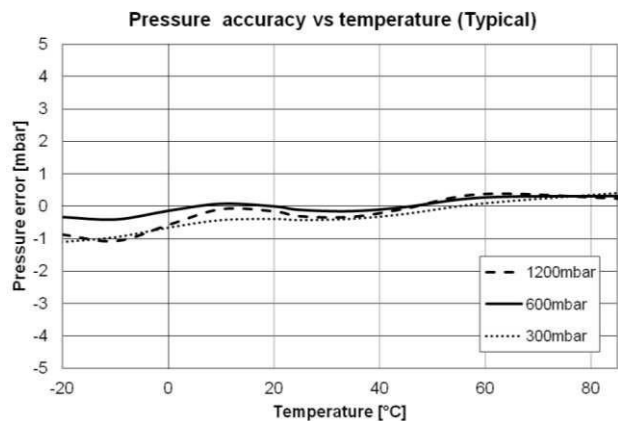
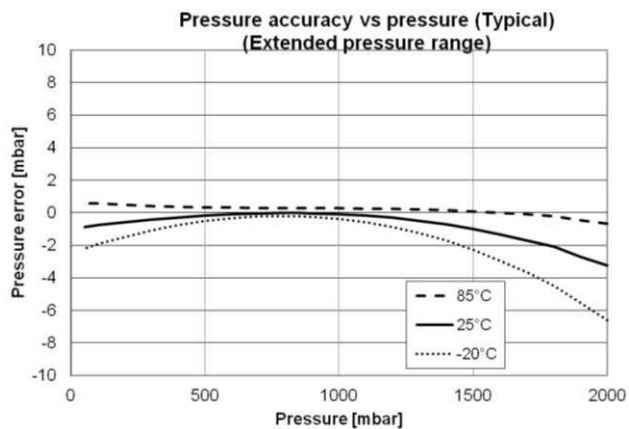
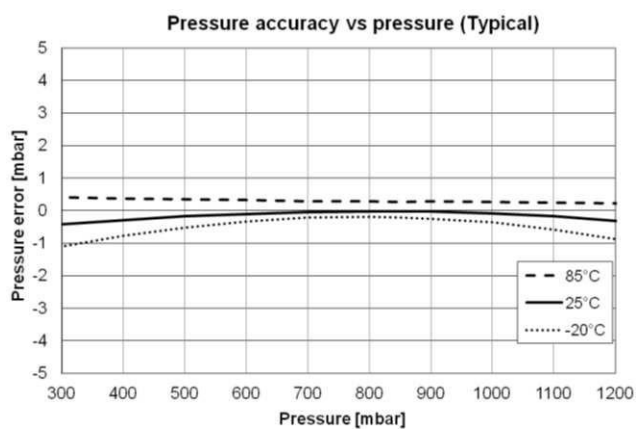



TYPICAL PERFORMANCE CHARACTERISTICS

RELATIVE PRESSURE AND TEMPERATURE ERROR VS TEMPERATURE (1ST ORDER AND 2ND ORDER ALGORITHM, TYPICAL VALUES)

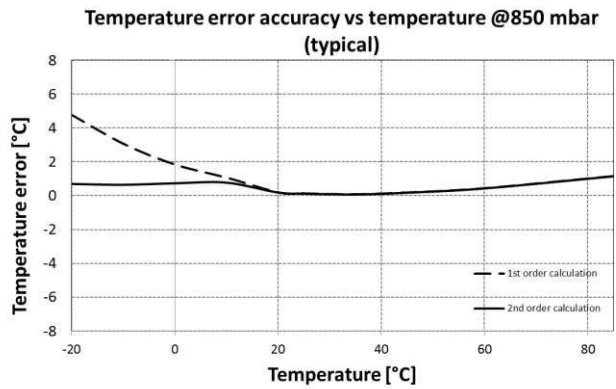
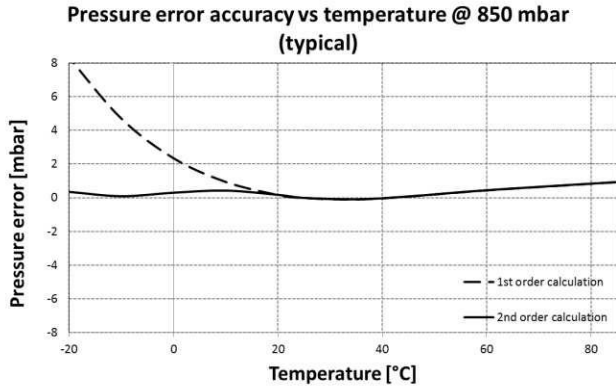

RELATIVE PRESSURE AND TEMPERATURE ERROR VS POWER SUPPLY (TYPICAL VALUES)

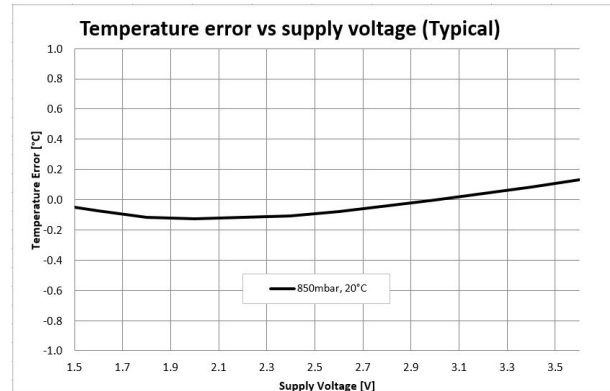
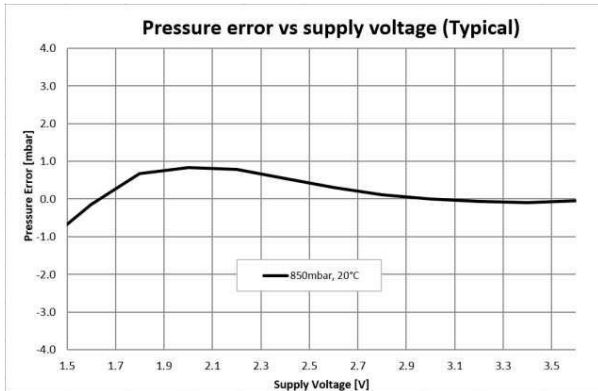



PRESSURE AND TEMPERATURE CALCULATION

GENERAL

The WF5837 consists of a piezo-resistive sensor and a sensor interface integrated circuit. The main function of the WF5837 is to convert the uncompensated analogue output voltage from the piezo-resistive pressure sensor to a 24-bit digital value, as well as providing a 24-bit digital value for the temperature of the sensor.

FACTORY CALIBRATION

Every module is individually factory calibrated at two temperatures and two pressures. As a result, 6 coefficients necessary to compensate for process variations and temperature variations are calculated and stored in the 112-bit PROM of each module. These bits (partitioned into 6 coefficients) must be read by the microcontroller software and used in the program converting D1 and D2 into compensated pressure and temperature values.

COMMUNICATION INTERFACE

The WF5837 has been built with I²C serial interface.

| Module ref | Mode | Pins used |
|---------------|------------------|-----------|
| WF5837-02BA01 | I ² C | SDA, SCL |

The external microcontroller clocks in the data through the input SCL (Serial CLock) and SDA (Serial DAta). The sensor responds on the same pin SDA which is bidirectional for the I²C bus interface. So this interface type uses only 2 signal lines and does not require a chip select.



PRESSURE AND TEMPERATURE CALCULATION

Start
 Maximum values for calculation results:
 $P_{MIN} = 10\text{mbar}$ $P_{MAX} = 2000\text{mbar}$
 $T_{MIN} = -40^{\circ}\text{C}$ $T_{MAX} = 85^{\circ}\text{C}$ $T_{REF} = 20^{\circ}\text{C}$

Read calibration data (factory calibrated) from PROM

| Variable | Description Equation | Recommended variable type | Size ^[1] [bit] | Value | | Example / Typical |
|----------|--|---------------------------|------------------------------|-------|-------|-------------------|
| | | | | min | max | |
| C1 | Pressure sensitivity $SENS_{T1}$ | unsigned int 16 | 16 | 0 | 65535 | 46372 |
| C2 | Pressure offset OFF_{T1} | unsigned int 16 | 16 | 0 | 65535 | 43981 |
| C3 | Temperature coefficient of pressure sensitivity TCS | unsigned int 16 | 16 | 0 | 65535 | 29059 |
| C4 | Temperature coefficient of pressure offset TCO | unsigned int 16 | 16 | 0 | 65535 | 27842 |
| C5 | Reference temperature T_{REF} | unsigned int 16 | 16 | 0 | 65535 | 31553 |
| C6 | Temperature coefficient of the temperature TEMPSSENS | unsigned int 16 | 16 | 0 | 65535 | 28165 |

Read digital pressure and temperature data

| | | | | | | |
|----|---------------------------|-----------------|----|---|----------|---------|
| D1 | Digital pressure value | unsigned int 32 | 24 | 0 | 16777216 | 6465444 |
| D2 | Digital temperature value | unsigned int 32 | 24 | 0 | 16777216 | 8077636 |

Calculate temperature

| | | | | | | |
|------|--|---------------|----|-----------|----------|--------------------|
| dT | Difference between actual and reference temperature ^[2] $dT = D2 - T_{REF} = D2 - C5 * 2^6$ | signed int 32 | 25 | -16776960 | 16777216 | 68 |
| TEMP | Actual temperature (-40...85°C with 0.01°C resolution) $TEMP = 20^{\circ}\text{C} + dT * TEMPSSENS = 2000 + dT * C6 / 2^{23}$ | signed int 32 | 41 | -4000 | 8500 | 2000 = 20.00 °C |

Calculate temperature compensated pressure

| | | | | | | |
|------|--|---------------|----|--------------|-------------|--------------------------|
| OFF | Offset at actual temperature ^[3] $OFF = OFF_{T1} + TCO * dT = C2 * 2^{17} + (C4 * dT) / 2^6$ | signed int 64 | 41 | -17179344900 | 25769410560 | 5764707214 |
| SENS | Sensitivity at actual temperature ^[4] $SENS = SENS_{T1} + TCS * dT = C1 * 2^{16} + (C3 * dT) / 2^7$ | signed int 64 | 41 | -8589672450 | 12884705280 | 3039050829 |
| P | Temperature compensated pressure (10...1200mbar with 0.01mbar resolution) $P = D1 * SENS - OFF = (D1 * SENS / 2^{21} - OFF) / 2^{15}$ | signed int 32 | 58 | 1000 | 120000 | 110002 = 1100.02 mbar |

Pressure and temperature value first order

- Notes
 [1] Maximal size of intermediate result during evaluation of variable min and max have to be defined
 [2] min and max have to be defined
 [3] min and max have to be defined
 [4] min and max have to be defined

Flow chart for pressure and temperature reading and software compensation



SECOND ORDER TEMPERATURE COMPENSATION

The results of the last first order calculation are entered in the following chart to obtain the pressure and temperature compensated with the 2nd order: P2 and TEMP2.

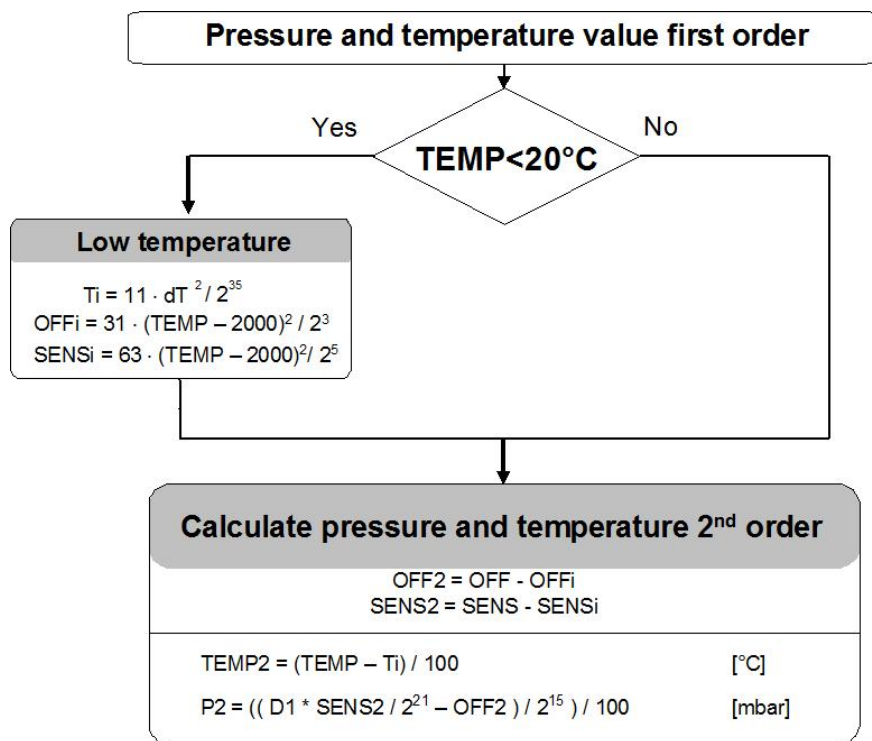

Flow chart for pressure and temperature to the optimum accuracy



I²C INTERFACE

COMMANDS

The WF5837 has only five basic commands:

1. Reset
2. Read PROM (112 bit of calibration words)
3. D1 conversion
4. D2 conversion
5. Read ADC result (24 bit pressure / temperature)

Each I²C communication message starts with the start condition and it is ended with the stop condition. The WF5837 address is 1110110x (write: x=0, read: x=1).

Size of each command is 1 byte (8 bits) as described in the table below. After ADC read commands, the device will return 24 bit result and after the PROM read 16 bit results. The address of the PROM is embedded inside of the PROM read command using the a2, a1 and a0 bits.

| Bit number | Command byte | | | | | | | | hex value |
|-----------------------|--------------|----------|---|-----|-------------|-------------|-------------|------|-----------------|
| | 0 | 1 | 2 | 3 | 4 | 5 | 6 | 7 | |
| Bit name | PRO M | CO NV | - | Typ | Ad2/ Os2 | Ad1/ Os1 | Ad0/ Os0 | Stop | |
| Command | | | | | | | | | |
| Reset | 0 | 0 | 0 | 1 | 1 | 1 | 1 | 0 | 0x1E |
| Convert D1 (OSR=256) | 0 | 1 | 0 | 0 | 0 | 0 | 0 | 0 | 0x40 |
| Convert D1 (OSR=512) | 0 | 1 | 0 | 0 | 0 | 0 | 1 | 0 | 0x42 |
| Convert D1 (OSR=1024) | 0 | 1 | 0 | 0 | 0 | 1 | 0 | 0 | 0x44 |
| Convert D1 (OSR=2048) | 0 | 1 | 0 | 0 | 0 | 1 | 1 | 0 | 0x46 |
| Convert D1 (OSR=4096) | 0 | 1 | 0 | 0 | 1 | 0 | 0 | 0 | 0x48 |
| Convert D1 (OSR=8192) | 0 | 1 | 0 | 0 | 1 | 0 | 1 | 0 | 0x4A |
| Convert D2 (OSR=256) | 0 | 1 | 0 | 1 | 0 | 0 | 0 | 0 | 0x50 |
| Convert D2 (OSR=512) | 0 | 1 | 0 | 1 | 0 | 0 | 1 | 0 | 0x52 |
| Convert D2 (OSR=1024) | 0 | 1 | 0 | 1 | 0 | 1 | 0 | 0 | 0x54 |
| Convert D2 (OSR=2048) | 0 | 1 | 0 | 1 | 0 | 1 | 1 | 0 | 0x56 |
| Convert D2 (OSR=4096) | 0 | 1 | 0 | 1 | 1 | 0 | 0 | 0 | 0x58 |
| Convert D2 (OSR=8192) | 0 | 1 | 0 | 1 | 1 | 0 | 1 | 0 | 0x5A |
| ADC Read | 0 | 0 | 0 | 0 | 0 | 0 | 0 | 0 | 0x00 |
| PROM Read | 1 | 0 | 1 | 0 | Ad2 | Ad1 | Ad0 | 0 | 0xA0 to 0xAE |

Command structu



RESET SEQUENCE

The Reset sequence shall be sent once after power-on to make sure that the calibration PROM gets loaded into the internal register. It can be also used to reset the device PROM from an unknown condition. The reset can be sent at any time. In the event that there is not a successful power on reset this may be caused by the SDA being blocked by the module in the acknowledge state. The only way to get the WF5837 to function is to send several SCLs followed by a reset sequence or to repeat power on reset.

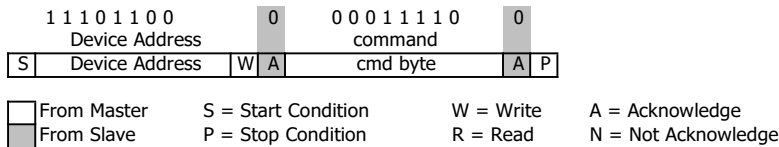

I²C Reset Command

PROM READ SEQUENCE

The read command for PROM shall be executed once after reset by the user to read the content of the calibration PROM and to calculate the calibration coefficients. There are in total 7 addresses resulting in a total memory of 112 bit. Addresses contain factory data and the setup, calibration coefficients, the serial code and CRC. The command sequence is 8 bits long with a 16 bit result which is clocked with the MSB first. The PROM Read command consists of two parts. First command sets up the system into PROM read mode. The second part gets the data from the system.

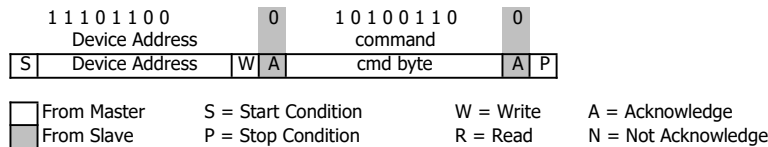

I²C Command to read memory address= 011

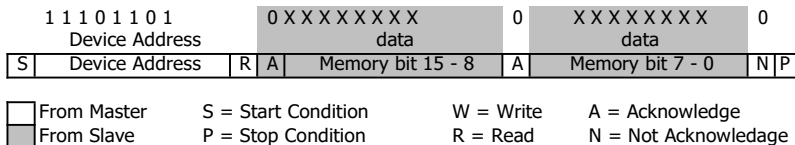

I²C answer from WF5837



CONVERSION SEQUENCE

The conversion command is used to initiate uncompensated pressure (D1) or uncompensated temperature (D2) conversion. After the conversion, using ADC read command the result is clocked out with the MSB first. If the conversion is not executed before the ADC read command, or the ADC read command is repeated, it will give 0 as the output result. If the ADC read command is sent during conversion the result will be 0, the conversion will not stop and the final result will be wrong. Conversion sequence sent during the already started conversion process will yield incorrect result as well. A conversion can be started by sending the command to WF5837. When command is sent to the system it stays busy until conversion is done. When conversion is finished the data can be accessed by sending a Read command, when an acknowledge is sent from the WF5837, 24 SCL cycles may be sent to receive all result bits. Every 8 bits the system waits for an acknowledge signal.

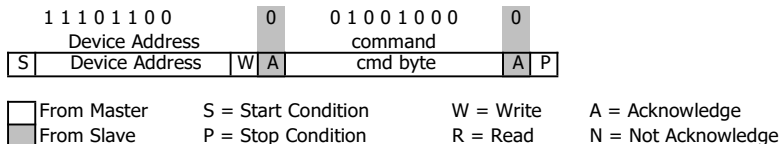

I²C command to initiate a pressure conversion (OSR=4096, typ=D1)

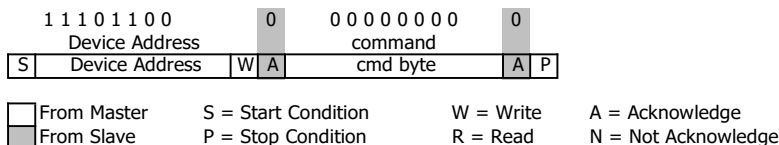

I²C ADC read sequence

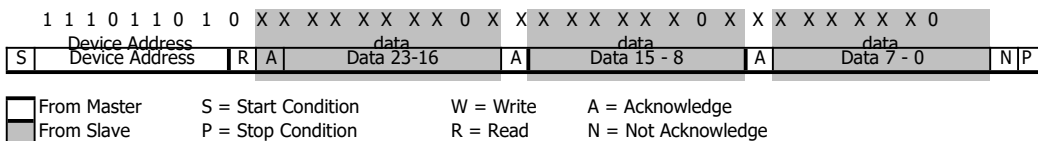

I²C answer from WF5837



Version PROM Word 0 programming

For product type, the bits [11:5] of memory address 0 must be programmed with the following fixed values:

WF5837-02BA01

| Address | 15 | 14 | 13 | 12 | 11 | 10 | 9 | 8 | 7 | 6 | 5 | 4 | 3 | 2 | 1 | 0 |
|---------|------------|----|----|----|----|----|---|---|---|---|---|-------------------------|---|---|---|---|
| 0 | <i>crc</i> | | | | 0 | 0 | 0 | 0 | 0 | 0 | 0 | <i>factory settings</i> | | | | |

WF5837-02BA21

| Address | 15 | 14 | 13 | 12 | 11 | 10 | 9 | 8 | 7 | 6 | 5 | 4 | 3 | 2 | 1 | 0 |
|---------|------------|----|----|----|----|----|---|---|---|---|---|-------------------------|---|---|---|---|
| 0 | <i>crc</i> | | | | 0 | 0 | 1 | 0 | 1 | 0 | 1 | <i>factory settings</i> | | | | |



CYCLIC REDUNDANCY CHECK (CRC)

WF5837 contains a PROM memory with 112-Bit. A 4-bit CRC has been implemented to check the data validity in memory.

| WF5837-02BA | | | | | | | | | | | | | | | | | |
|-------------|-----|---|---|---|-----------------|---|----|---|---|---|-----------------|---|---|---|---|---|--|
| A | D | D | D | D | D | D | D | D | D | D | D | D | D | D | D | D | |
| d | B | B | B | B | B | B | B | B | B | B | B | B | B | B | B | B | |
| d | 1 | 1 | 1 | 1 | 1 | 1 | 9 | 8 | 7 | 6 | 5 | 4 | 3 | 2 | 1 | 0 | |
| 0 | CRC | | | | Version defined | | | | | | Factory defined | | | | | | |
| 1 | | | | | | | C1 | | | | | | | | | | |
| 2 | | | | | | | C2 | | | | | | | | | | |
| 3 | | | | | | | C3 | | | | | | | | | | |
| 4 | | | | | | | C4 | | | | | | | | | | |
| 5 | | | | | | | C5 | | | | | | | | | | |
| 6 | | | | | | | C6 | | | | | | | | | | |

Memory PROM mapping

C Code example for CRC-4 calculation:

```

unsigned char crc4(unsigned int n_prom[]) // n_prom defined as 8x unsigned int (n_prom[8])
{
    int cnt; // simple counter
    unsigned int n_rem=0; // crc remainder
    unsigned char n_bit;

    n_prom[0]=((n_prom[0]) & 0x0FFF); // CRC byte is replaced by 0
    n_prom[7]=0; // Subsidiary value, set to 0
    for (cnt = 0; cnt < 16; cnt++) // operation is performed on bytes
    { // choose LSB or MSB
        if (cnt%2==1) n_rem ^= (unsigned short) ((n_prom[cnt]>>1] & 0x00FF);
        else n_rem ^= (unsigned short) (n_prom[cnt]>>1]>>8);
        for (n_bit = 8; n_bit > 0; n_bit--)
        {
            if (n_rem & (0x8000)) n_rem = (n_rem << 1) ^ 0x3000;
            else n_rem = (n_rem << 1);
        }
    }
    n_rem = ((n_rem >> 12) & 0x000F); // final 4-bit remainder is CRC code
    return (n_rem ^ 0x00);
}

```

APPLICATION CIRCUIT

The WF5837 is a circuit that can be used in conjunction with a microcontroller in mobile altimeter applications.

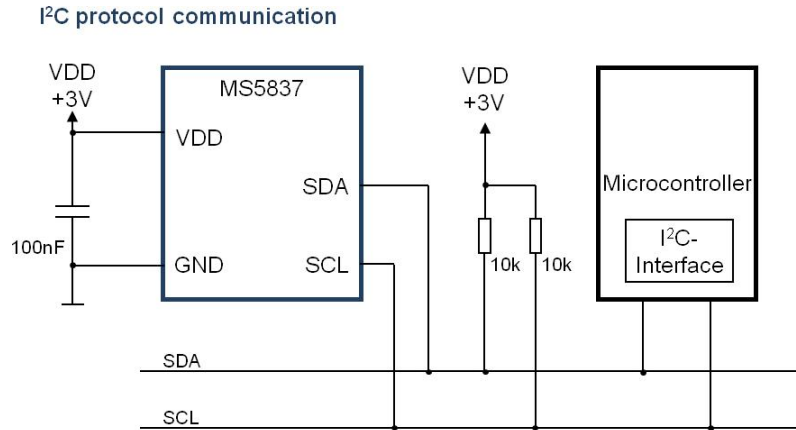
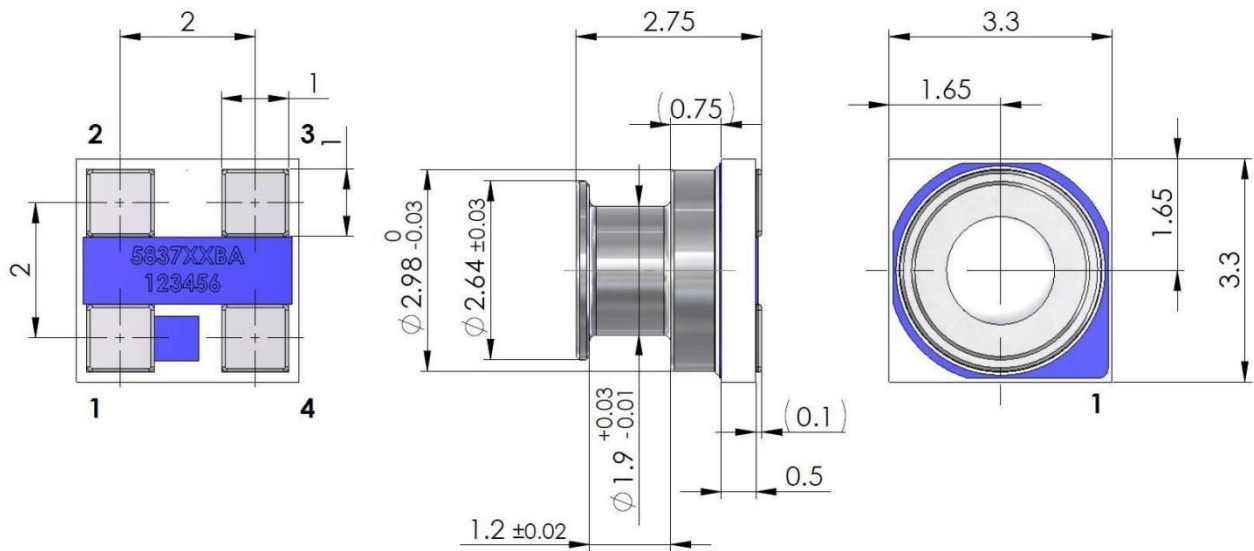

Figure: Typical application circuit

PIN CONFIGURATION AND DEVICE PACKAGE OUTLINE

UNLESS OTHERWISE SPECIFIED DIMENSIONS ARE IN MILLIMETERS. GENERAL TOLERANCE $\pm 0.15\text{mm}$



| | | |
|---|-----|------------------------|
| 1 | GND | GROUND |
| 2 | VDD | POSITIVE SUPPLY |
| 3 | SCL | I ² C CLOCK |
| 4 | SDA | I ² C DATA |

Figure: Package outlines and Pin configuration



MOUNTING AND ASSEMBLY CONSIDERATIONS

SOLDERING

Please refer to the application note AN808 available on our website for soldering recommendations.

MOUNTING

The WF5837 can be placed with automatic Pick & Place equipment using vacuum nozzles. It will not be damaged by the vacuum.

Due to the low stress assembly, the sensor does not show pressure hysteresis effects. It is important to solder all contact pads. Gel must stay free of external physical contact when manipulation.

CONNECTION TO PCB

The package outline of the module allows the use of a flexible PCB for interconnection. This can be important for applications in watches and other special devices.

SEALING WITH O-RINGS

In applications such as outdoor watches the electronics must be protected against direct water or humidity. For such applications the WF5837 provides the possibility to seal with an O-ring. The O-ring shall be placed at the groove location, i.e. the small outer diameter of the metal lid. The following O-ring / housing dimensions are recommended:

| | |
|-------------------------------|--------------------|
| O-ring inner diameter | 1.8 ± 0.05 mm |
| O-ring cross-section diameter | 0.8 ± 0.03 mm |
| Housing bore diameter | 3.07 ± 0.03 mm |

Please refer to the application note AN523 available on our website for O-ring mounting recommendations.

CLEANING

The WF5837 has been manufactured under clean-room conditions. It is therefore recommended to assemble the sensor under class 10'000 or better conditions. Should this not be possible, it is recommended to protect the sensor opening during assembly from entering particles and dust. To avoid cleaning of the PCB, solder paste of type "no-clean" shall be used. Warning: cleaning might damage the sensor.

ESD PRECAUTIONS

The electrical contact pads are protected against ESD. It is therefore essential to ground machines and personnel properly during assembly and handling of the device. The WF5837 is shipped in antistatic transport boxes. Any test adapters or production transport boxes used during the assembly of the sensor shall be of an equivalent antistatic material.

DECOUPLING CAPACITOR

Particular care must be taken when connecting the device to the power supply. A 100nF minimum ceramic capacitor must be placed as close as possible to the WF5837 VDD pin. This capacitor will stabilize the power supply during data conversion and thus, provide the highest possible accuracy.

SHIELDING

This option is recommended for sensors installed in plastic housings or in high electrical noise environments in order to reduce signal noise and interference that may be experienced.



ORDERING INFORMATION

| PART NUMBER | DESCRIPTION | SHIELDING |
|-----------------|---------------------------------------|-----------|
| WF583702BA01-50 | WF5837-02BA01 2BA T&R PRESSURE SEN | |
| 20000979-00 | WF5837-02BA21 2BA LS T&R PRESSURE SEN | X |

