



Digital Barometer

Key parameters

- Pressure range: 10 ... 12000hPa
- Package: 8-pin LGA metal-lid
Footprint: 6.2 × 6.8mm²
Height: 3.3mm
- Relative accuracy: ±0.03 hPa(±0.25m)
- Absolute accuracy: typ. ±1.5hPa
- Temperature coefficient offset: 1.5 Pa/K,
(12.6 cm/K)
- Digital interface: I²C/SPI
- Current consumption: 3.5µA @1Hz
sampling rate
- Temperature range: -40~+125°C
- RoHs compliant, halogen-free

Typical applications

- Barometer and altimeter for portable devices
- Indoor and outdoor navigation
- Weather station equipment
- Sport watches
- Flying toys

Technical advantages

- Wide compensate temperature
-40~+125°C
- Small package, height only 3.3mm
- Excellent performance and cost

Brief Description

WF5803F is a high precision barometer and altimeter especially designed for consumer applications. It measures the pressure based on piezo-resistive MEMS pressure sensor.

The ultra-low power, low voltage electronics of the WF5803F is optimized for use in mobile phones, smart watches, PDAs, GPS navigation devices and outdoor equipment. The sensor module is housed in a compact 8-pin metal-lid LGA package with a footprint of only 6.2 × 6.8 mm² and 3.3 mm package height. Its small dimensions and its low power consumption allow the implementation in battery driven devices. With a low altitude noise of merely 0.08m and very low offset temperature coefficient(TCO), the WF5803F offers superior performance and cost are perfectly suitable for applications like flying toys and sport watches. The I²C/SPI interface allows for easy system integration with a microcontroller.



1 Specification

VDD = 3.3V, T=25°C, unless otherwise noted.

Table 1 Parameter specification

Parameter	Symbol	Condition	Min	Typ	Max	Units
Operating temperature range	T _A	operational	-40	25	+125	°C
		full accuracy	0		65	
Operating pressure range	P	full accuracy	10		3000	kPa
Sensor supply voltage	V _{DD}		1.8		3.6	V
Interface supply voltage	V _{DDIO}		1.8		3.6	V
Supply current	I _{DD, LP}	1Hz, ultra low power		3.5		µA
Peak current	I _{peak}	during pressure measurement		1950		µA
Current at temperature measurement	I _{DDT}			900		µA
Sleep current	I _{DDSL}	25°C		0.1	0.3	µA
Relative accuracy VDD=3.3V	A _{rel}	700...900hPa		±0.03		hPa
		25...40°C		±0.25		m
Offset temperature coefficient	TCO	900hPa		±1.5		Pa/K
		25...40°C		±12.6		cm/K
Absolute accuracy pressure		10 ... 30000hPa -20...0°C 60...80 °C		±2.0		hPa
		10 ... 1300hPa 0...60°C		±1.5		hPa
Resolution of output data in ultra high resolution mode		Pressure		0.025		Pa
		Temperature		0.01		°C
Noise in pressure	V _{p,full}	Full bandwidth, ultra high resolution		1		Pa
				8		cm
	V _{p,filtered}	Lowest bandwidth, ultra high resolution		0.2		Pa
				1.7		cm
Absolute accuracy temperature	A ^T	@25°C		±0.5		°C
		0...+65°C		±1.0		°C
PSRR (DC)	PSSR	Full V _{DD} range			±0.005	Pa/mV
Long term stability	ΔPstab	12 months		TBD		hPa
Solder drifts			-0.5		+2	hPa
Possible sampling rate	f _{sample}		587	649	TBD	Hz



2 Absolute maximum ratings

Table 2 Absolute maximum ratings

Parameter	Symbol	Condition	Min	Max	Units
Supply voltage	V_{DD}		-0.3	+3.6	V
Voltage at all IO Pins	V_{DDIO}	all pins	-0.3	$V_{DD}+0.3$	V
Overpressure	P		0	30,000	hPa
Storage temperature	T_{STOR}		-45	+150	°C
ESD rating	ESD	HBM		±2	kV

3 Operation

3.1 Brief description

The WF5803F is designed to be connected directly to an external microcontroller of a mobile device via the I²C or SPI bus. The pressure and temperature data has to be compensated by the calibration data of the on-chip Non-Volatile Memory (NVM) which is individually factory calibrated for each device.

3.2 Function description

The WF5803F consists of a piezo-resistive micro-machined pressure sensor, an analog to digital converter and a control unit with Non-Volatile Memory (NVM) and a serial I²C/SPI interface. The WF5803F delivers the uncompensated values of the pressure and the temperature. The individual calibration data are stored in NVM. This is used to compensate sensitivity, offset, temperature dependence and other parameters of the sensor.

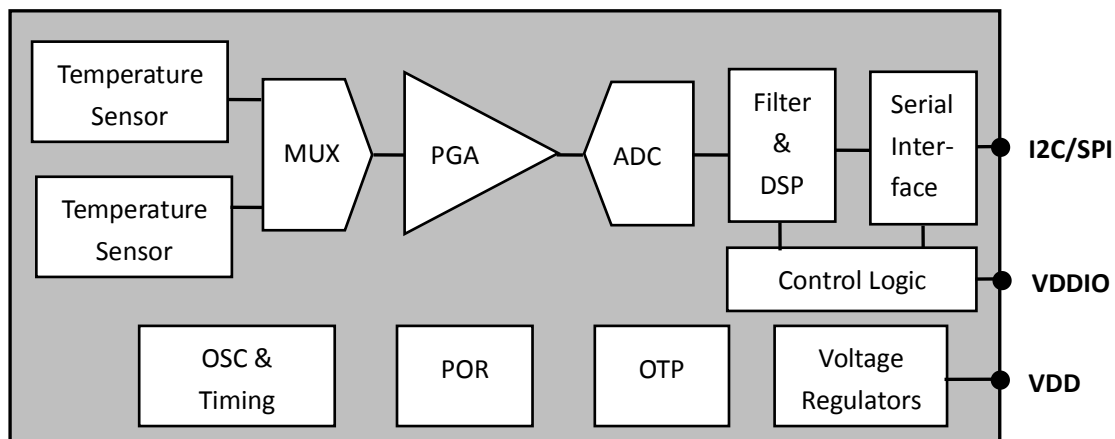

Figure 1 Block diagram of WF5803F

3.3 Measurement of pressure and temperature

The microcontroller sends I²C/SPI write register to start a pressure or temperature measurement. After converting time or checking status via the I²C/SPI, the result value (raw pressure data and raw temperature data) can be read via the I²C/SPI interface. For pressure and temperature calibration calculation in microcontroller, the calibration data in NVM has to be used. The constants can be read out from the WF5803F's NVM via the I²C/SPI interface at software initialization.

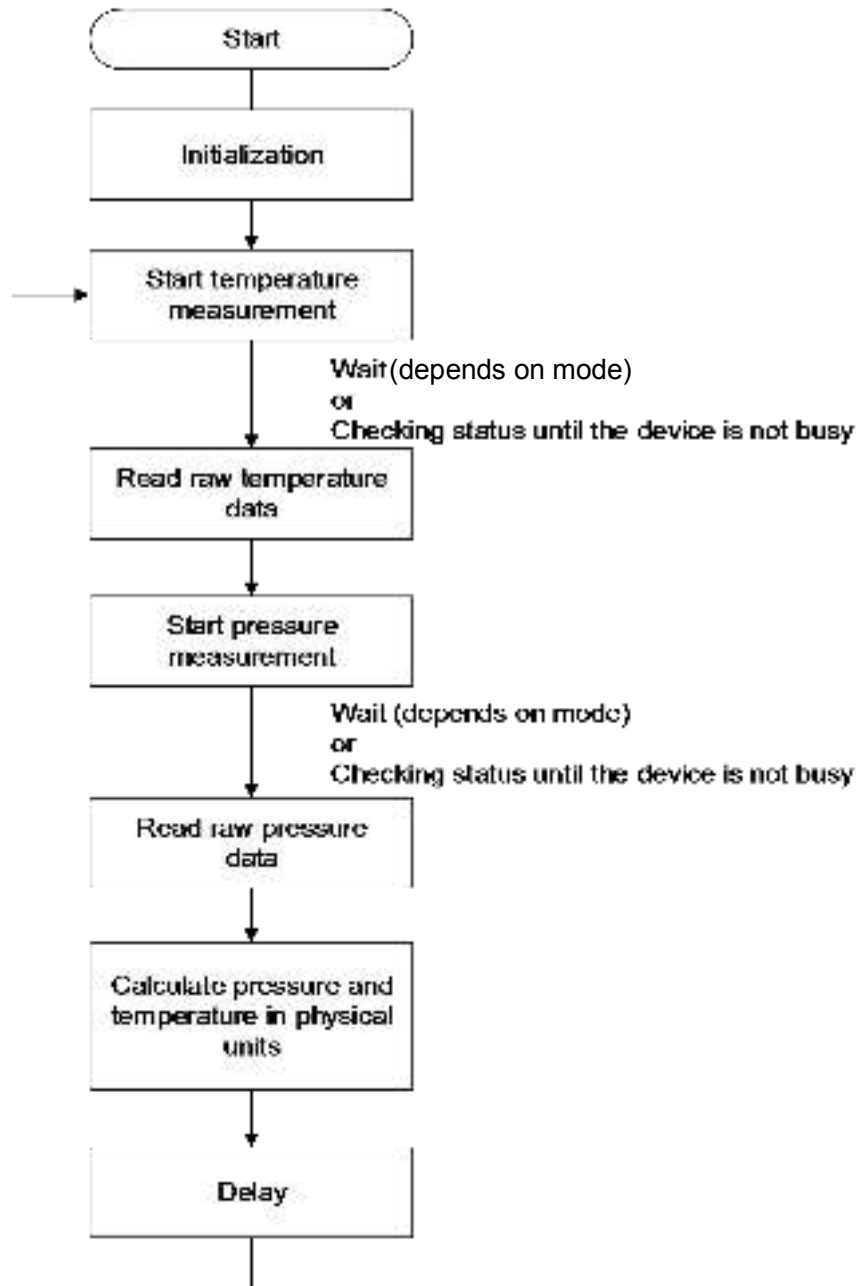

Figure 2 Measurement flow of WF5803F

3.4 Timing of the measurements

The output data rate (ODR) of the measurements is controlled by the external microcontroller. A single measurement is performed according to the received I²C/SPI register value. When the measurement is finished, the sensor returns to sleep mode and the measurement results can be obtained via I²C/SPI interface.

The ODR can be increased to more than 500 samples per second for dynamic measurement. For application with high ODR, constant t_{delay} is recommended as the



self-heating of the pressure sensor and heat dissipation are in the balance if sampling rate is constant, which helps reducing the noise caused by irregular heat exchange between the sensor and the ambient environment. The recommended working timing diagram is shown in Figure 3.

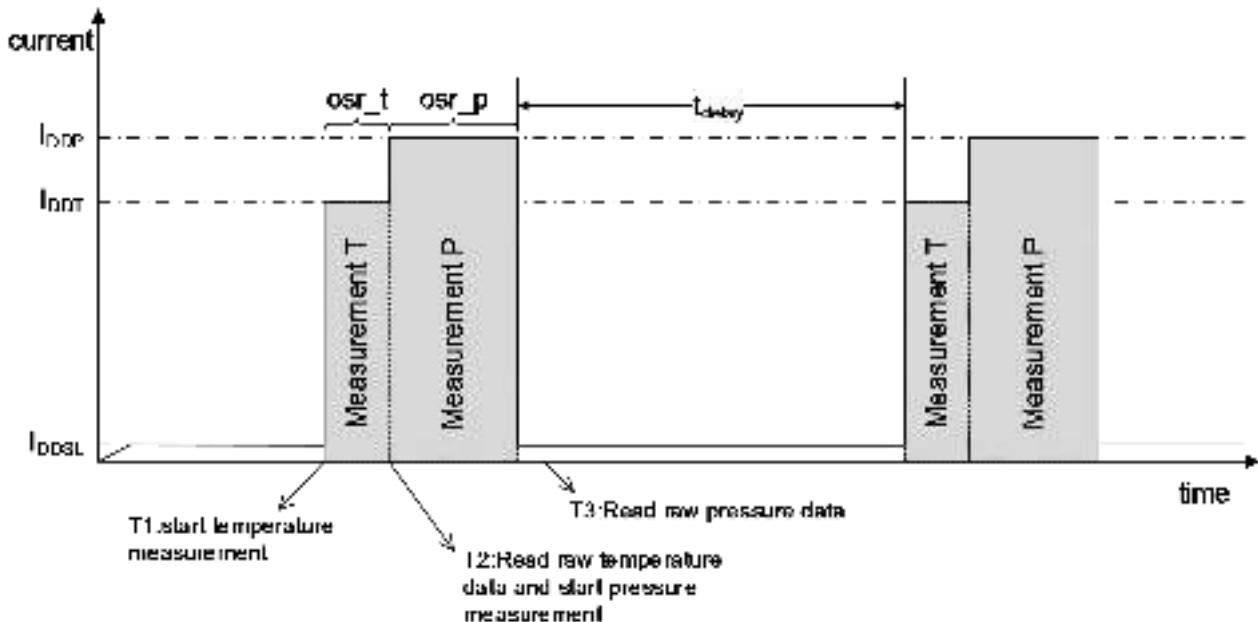

Figure 3 Recommended working timing diagram

For applications which require low ODR or host-based synchronization, the t_{delay} can be set with any value larger than 0.5ms. The optimum compromise between power consumption, speed and resolution can be selected.

3.5 Output compensation

The WF5803F output consists of the ADC output values include raw temperature and pressure data. Due to different characteristic of each sensing element, the actual pressure and temperature must be calculated using a set of calibration coefficients. These coefficients are individually factory calibrated and stored in the NVM. The NVM is organized with 16-bit data type.

3.6 Compensation formula

The ODR and OSR can be selected by selected by the oversampling_setting in the C code. Using the driver C code provided by WF Tech. Inc. is strongly recommended. Please contact with WF Tech. Inc. for details.



4 Registers

All the WF5803F registers can be departed into normal registers and OTP registers. The normal registers are used to send a conversion command to the WF5803F, read back the conversion data and perform the OTP blowing. The OTP registers are used to store the configurations and calibration coefficients for the WF5803F, whose default values can be programmed by the inside OTP banks.

4.1 Normal Registers

The WF5803F is designed to be connected directly to an external microcontroller of a mobile device via the I²C or SPI bus. The pressure and temperature data has to be compensated by the calibration data of the on-chip Non-Volatile Memory (NVM) which is individually factory calibrated for each device.

Table 4 Normal registers

Addr	Description	R/W	Bit7	Bit6	Bit5	Bit4	Bit3	Bit2	Bit1	Bit0	Default
0x00	SPI_Ctrl	RW	SDO_active	LSB_fi rst	Softre set			Softre set	LSB_ first	SDO_active	0x00
0x01	Part_ID	R	PartID<7:0>								0x00
0x02	Status		Error_code<3:0>						1'b0	DRDY	
0x06	DATA_MSB	R	Data out<23:16>								0x00
0x07	DATA_CSB	R	Data out<15:8>								0x00
0x08	DATA_LSB	R	Data out<7:0>								0x00
0x09	TEMP_MSB	R	Temp out<15:8>								0x00
0x0A	TEMP_LSB	R	Temp out<7:0>								0x00
0x30	CMD	RW	Sleep_time<3:0>				Sco	Measurement<2:0>			0x00

Reg0x00

SDO_active: 1: 4-wire SPI, 0: 3-wire SPI

LSB_first: 1: LSB first for SPI interface, 0: MSB first for SPI interface

Soft_reset: 1: Reset all the WF5803F registers (except 'margin'), automatically come back to 0 after reset complete.

Reg0x01

PartID: OTP programmed 8 bits Part ID.

Reg0x02

DRDY : 1, indicates once conversion complete, and the output data is ready for reading.



Error_code: When diagnostic function enabled, These bits stores the error information.

Error_code[3]: VINP short to VDD

Error_code[2]: VINP short to GND

Error_code[1]: VINN short to VDD

Error_code[0]: VINN short to GND

Reg0x06-Reg0x08

Data out: 24 bits ADC output data .

Reg0x09-Reg0x0a

Temp_out: Temperature output with an LSB equals to $(1/256)^{\circ}\text{C}$.

Reg0x30

Sleep_time<3:0>: 0000:0ms, 0001:62.5ms, 0010:125ms ... 1111: 1s, only active during sleep mode conversion.

Measurement_control<1:0>: 000b, indicate a single shot temperature signal conversion. 001b, indicate a single shot sensor signal conversion. 010b: indicate a combined conversion (once temperature conversion immediately followed by once sensor signal conversion). 011b: indicate a sleep mode conversion (periodically perform once combined conversion with an interval time of 'sleep_time').

Sco: 1, Start of conversion, automatically come back to 0 after conversion ends (except sleep mode conversion).

5 SPI interface

WF5803F provides both SPI and I2C interface for serial communication and 'CSB' pin is used to switch between these two protocols. Pulling 'CSB' pin low selects the SPI interface, leaving 'CSB' pin float or puling it high selects the I2C interface.

5.1 Interface Specification

Table 6 SPI interface specification

Symbol	Parameter	Condition	Min	Max	Unit
f_{sclk}	Clock frequency	Max load on SDIO or SDO=25pF		10	MHz
t_{sclk_l}	SCLK low pulse		20		ns
t_{sclk_h}	SCLK high pulse		20		
T_{sdi_setup}	SDI setup time		20		ns
T_{sdi_hold}	SDI hold time		20		ns
T_{sdo_od}	SDO/SDI output delay	Load = 25pF		30	ns
		Load = 250pF		40	
T_{csb_setup}	CSB setup time		20		ns
T_{csb_hold}	CSB hold time		40		ns

The figure below shows the definition of the SPI timing given in table 6

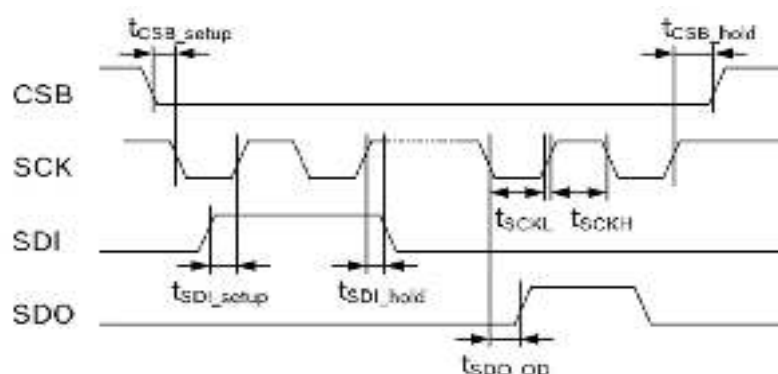

Figure 4 SPI timing diagram

The falling edge of CSB, in conjunction with the rising edge of SCLK, determines the start of framing. Once the



beginning of the frame has been determined, timing is straightforward. The first phase of the transfer is the instruction phase, which consists of 16 bits followed by data that can be of variable lengths in multiples of 8 bits. If the device is configured with CSB tied low, framing begins with the first rising edge of SCLK.

The instruction phase is the first 16 bits transmitted. As shown in Figure 5.2, the instruction phase is divided into a number of bit fields.

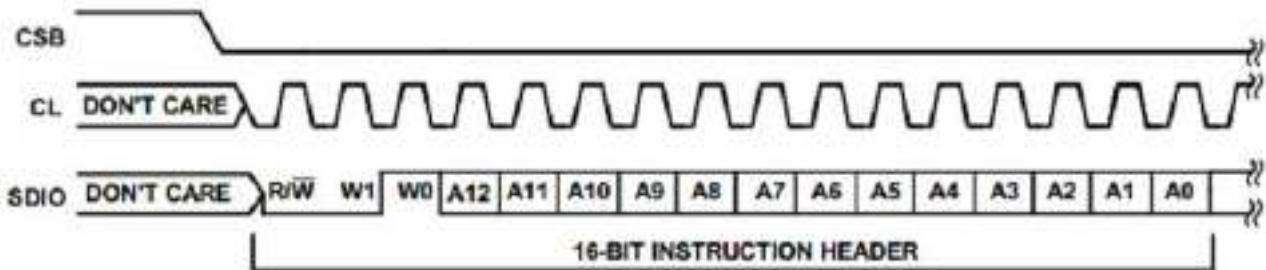

Figure 5 Instruction Phase Bit Filed

The first bit in the stream is the read/write indicator bit (R/W). When this bit is high, a read is being requested, otherwise indicates it is a write operation.

W1 and W0 represent the number of data bytes to transfer for either read or write (Table 5.2). If the number of bytes to transfer is three or less (00, 01, or 10), CSB can stall high on byte boundaries. Stalling on a nonbyte boundary terminates the communications cycle. If these bits are 11, data can be transferred until CSB transitions high. CSB is not allowed to stall during the streaming process.

The remaining 13 bits represent the starting address of the data sent. If more than one word is being sent, sequential addressing is used, starting with the one specified, and it either increments (LSB first) or decrements (MSB first) based on the mode setting.

Table 7 W1 and W0 settings

W1:W0	Action	CSB stalling
00	1 byte of data can be transferred.	Optional
01	2 bytes of data can be transferred.	Optional
10	3 bytes of data can be transferred.	Optional
11	4 or more bytes of data can be transferred. CSB must be held low for entire sequence; otherwise, the cycle is terminated.	No

Data follows the instruction phase. The amount of data sent is determined by the word length (Bit W0 and Bit W1). This can be one or more bytes of data. All data is composed of 8-bit words.

Data can be sent in either MSB-first mode or LSB-first mode (by setting 'LSB_first' bit). On power up, MSB-first mode is the default.

This can be changed by programming the configuration register. In MSB-first mode, the serial exchange starts with the highest-order bit and ends with the LSB. In LSB-first mode, the order is reversed. (Figure 5.3)

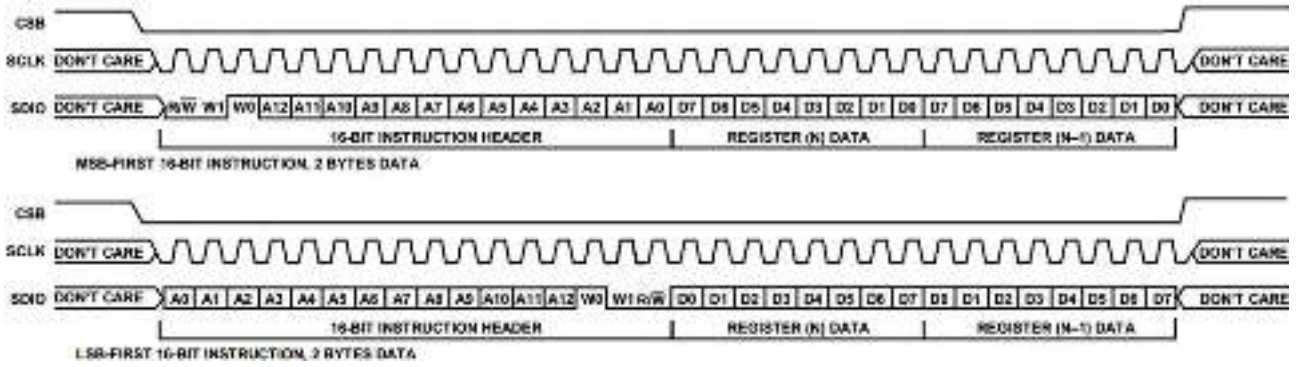

Figure 6 MSB First and LSB First Instruction and Data Phases

Register bit 'SDO_active' is responsible for activating SDO on devices. If this bit is cleared, then SDO is inactive and read data is routed to the SDIO pin. If this bit is set, read data is placed on the SDO pin. The default for this bit is low, making SDO inactive.



6 I2C INTERFACE

I2C bus uses SCL and SDA as signal lines. Both lines are connected to VDDIO externally via pull-up resistors so that they are pulled high when the bus is free. The I2C device address of WF5803F is shown below. The LSB bit of the 7bits device address is configured via SDO/ADDR pin.

Table 8 I2C Address

A7	A6	A5	A4	A3	A2	A1	W/R
1	1	0	1	1	0	SDO/ADDR	0/1

Electrical specification of the I2C interface pins

Symbol	Parameter	Condition	Min	Max	Unit
f_{SCL}	Clock frequency			400	kHz
t_{LOW}	SCL low pulse		1.3		us
t_{HIGH}	SCL high pulse		0.6		us
t_{SUDAT}	SDA setup time		0.1		us
t_{HDDAT}	SDA hold time		0.0		us
t_{SUSTA}	Setup Time for a repeated start condition		0.6		us
t_{HDSTA}	Hold time for a start condition		0.6		Us
t_{SUSTO}	Setup Time for a stop condition		0.6		Us
t_{BUF}	Time before a new transmission can start		1.3		Us

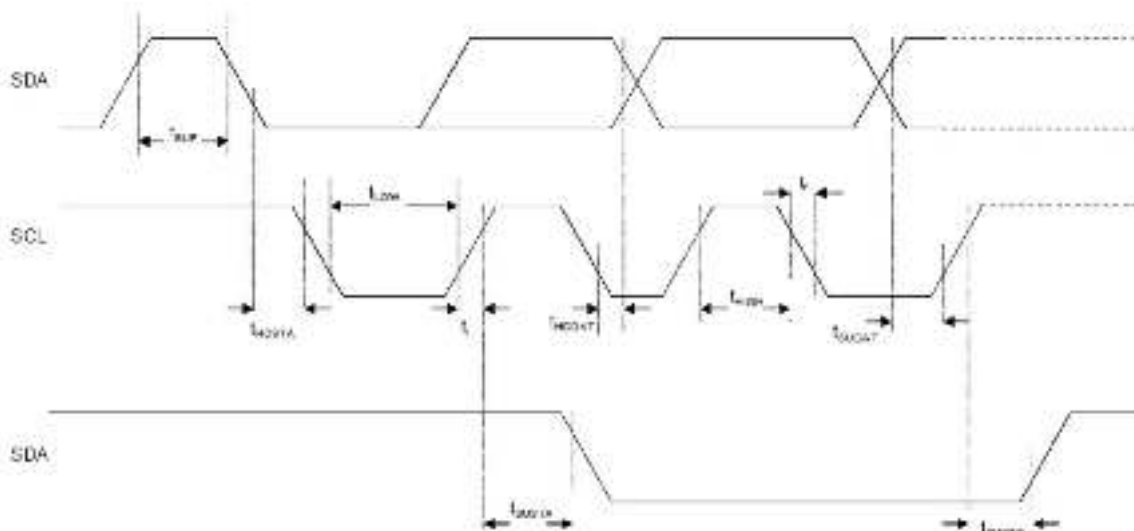

Figure 7 I2C Timing Diagram

The I2C interface protocol has special bus signal conditions. Start (S), stop (P) and binary data conditions are shown below. At start condition, SCL is high and SDA has a falling edge. Then the slave address is sent. After the 7 address bits, the direction control bit R/W selects the read or



write operation. When a slave device recognizes that it is being addressed, it should acknowledge by pulling SDA low in the ninth SCL (ACK) cycle.

At stop condition, SCL is also high, but SDA has a rising edge. Data must be held stable at SDA when SCL is high. Data can change value at SDA only when SCL is low.

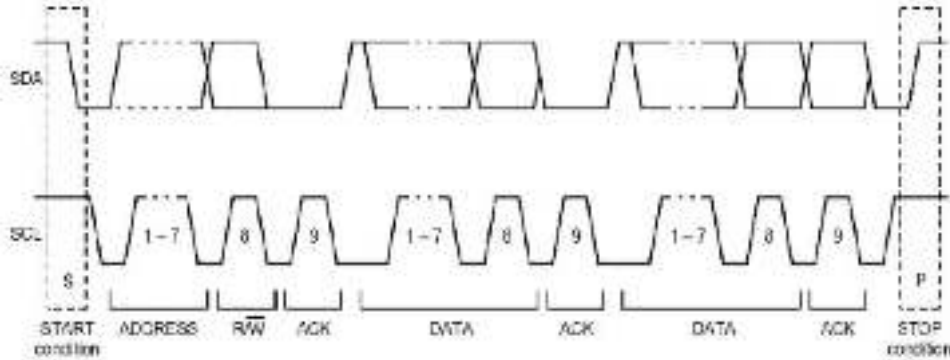
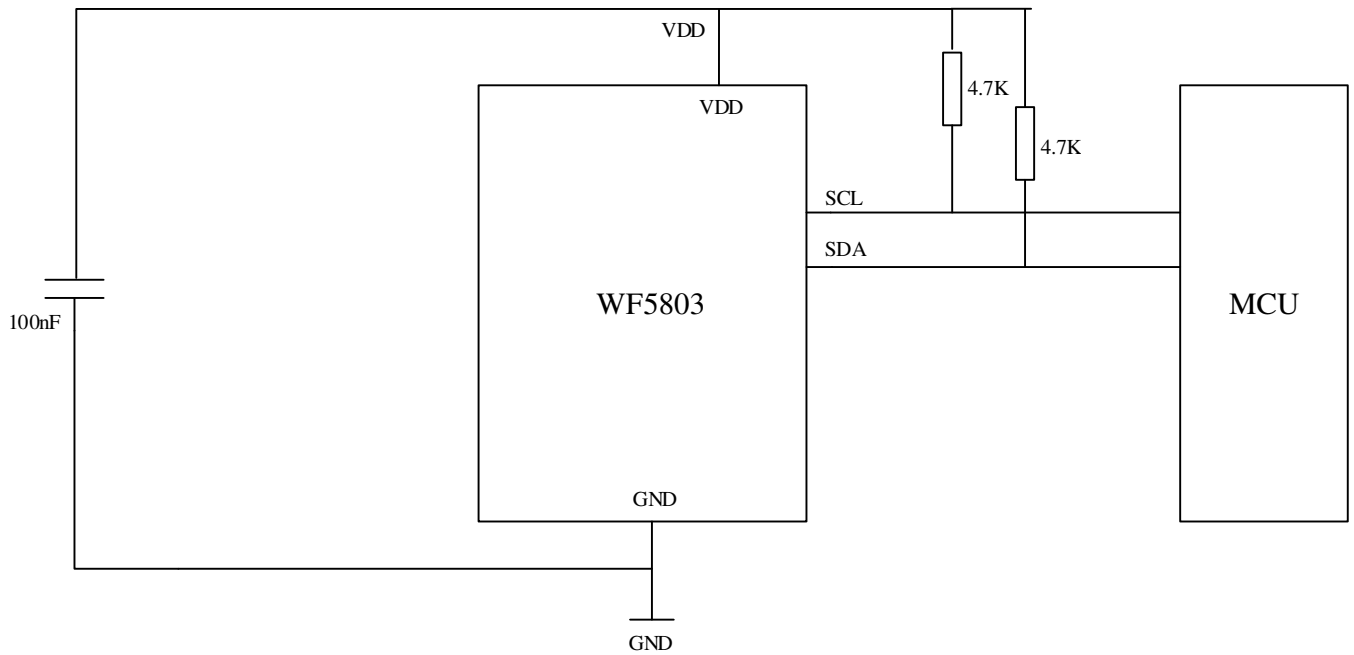

Figure 8 I2C Protocol



7 Connection diagram



Typical Application (I2C Mode)

Notes:

- The recommended value for C1 is 100nF
- The value for the pull-up resistors R1, R2 should be based on the interface timing and the bus load; a normal value of R1 is 4.7kΩ, R2 is 4.7kΩ.

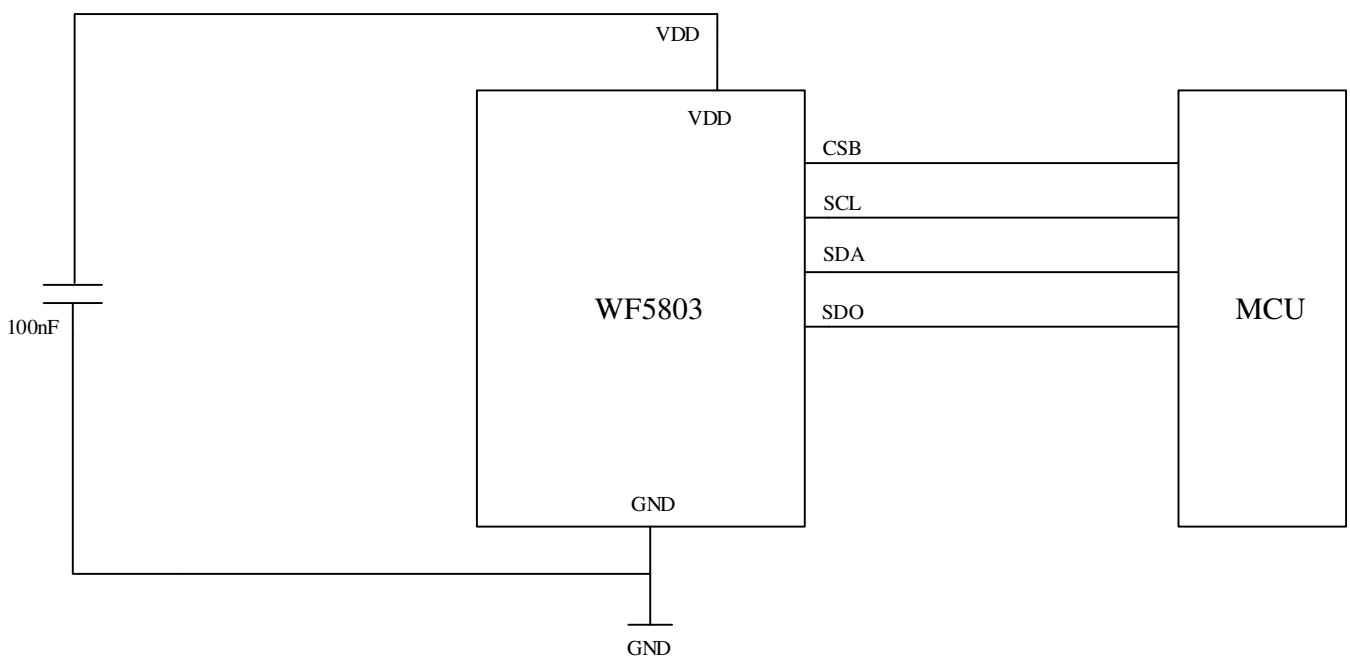

Typical Application (SPI Mode)

8 Package, reel and environment

8.1 Package Information

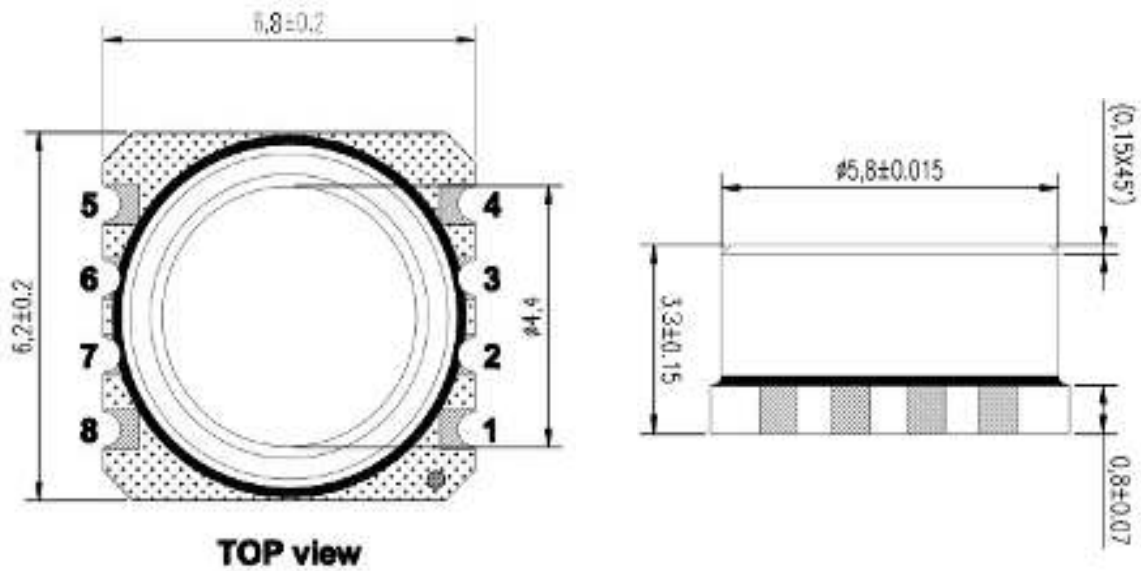

8.2 Pin Configuration

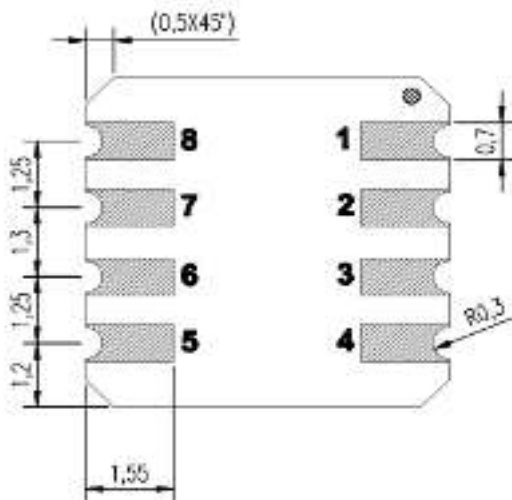

Pin	Name	Function
1	SCLK	Serial data clock
2	GND	Ground
3	CSB	CHIP SELECT
4	NC	
5	VDD	Positive supply voltage
6	NC	
7	SDA	Serial data
8	SDO	Address select in I2C mode

Notes:

Mechanical dimension is mm

8.3 Shipping Package

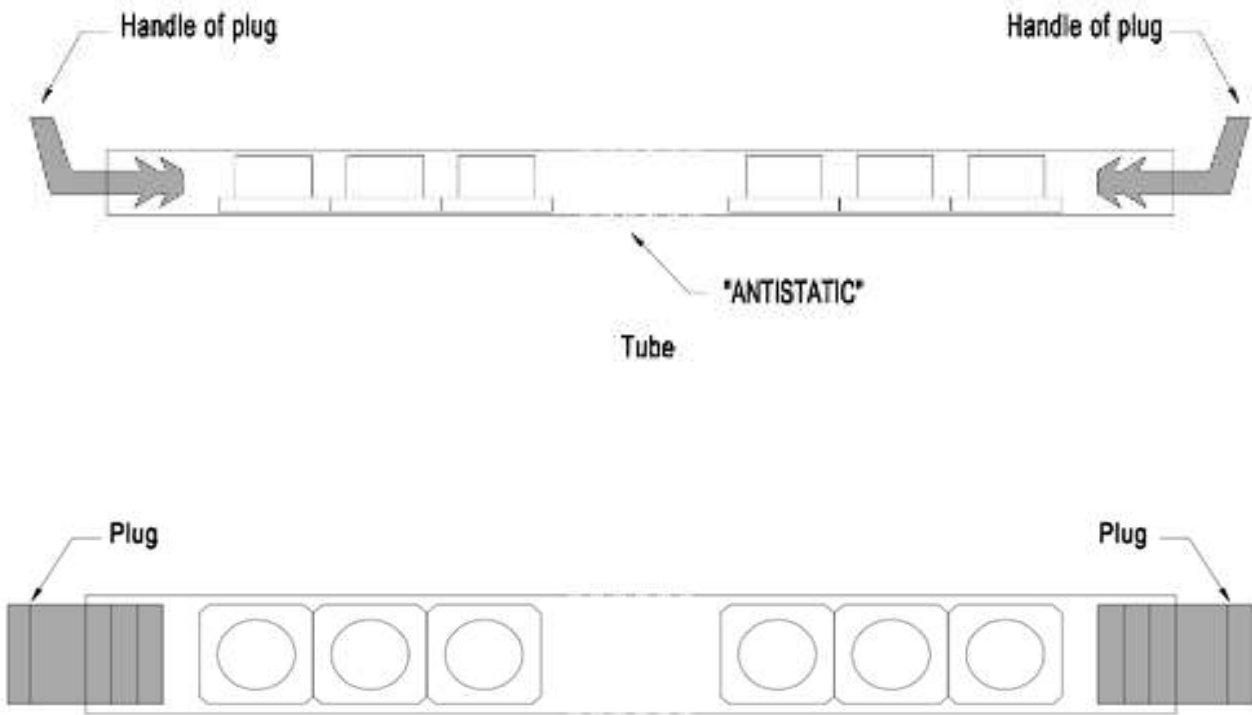

9 Soldering recommendation

The recommended soldering profile is shown in Figure 12, followed by a description of the profile features in Table 10.

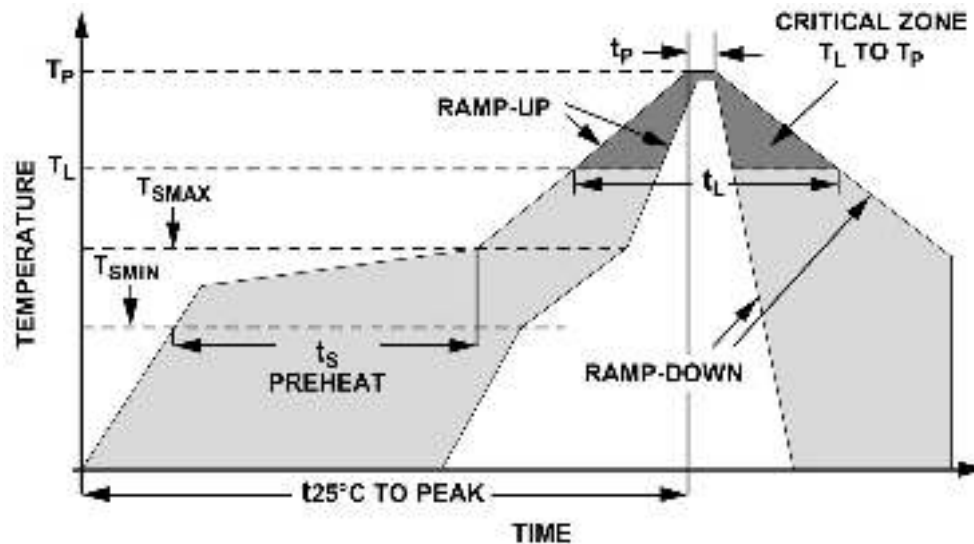

Figure 12 Recommended Soldering Profile

Table 10 Recommended Soldering Profile

Profile Feature	Pb-Free
Average ramp-up rate($T_{S\text{MAX}}$ to T_p)	3°C/sec max.
Preheat:	
-Temperature Min.($T_{S\text{MIN}}$)	150°C
-Temperature Max.($T_{S\text{MAX}}$)	200°C
-Time.($T_{S\text{MIN}}$ to $T_{S\text{MAX}}$)(t_s)	60 sec to 180 sec
Time maintained above:	
-Temperature(T_l)	217°C
-Time(t_L)	60 sec to 150 sec
Peak temperature(T_p)	260°C
Time within 5°C of actual peak temperature(T_p) ²	20 sec to 40 sec
Ramp-down rate	4°C/sec max.
Time 25°C to peak temperature	8 minutes max.